

C-1500N Typical Installation

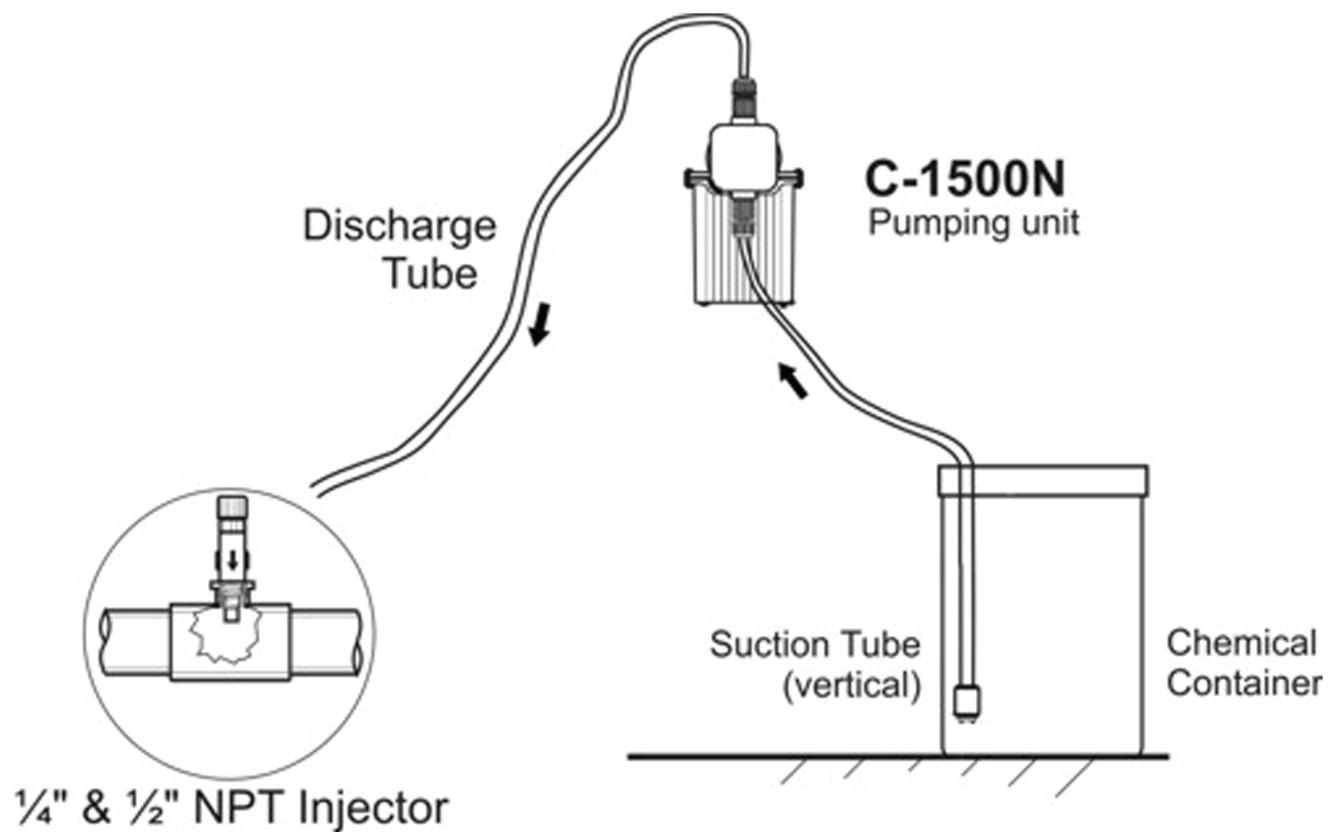

Mounting Location

1. Choose an area located near the chemical supply tank, chemical injection point and electrical supply. Although the pump is designed to withstand outdoor conditions, a cool, dry, well-ventilated location is recommended. Install the pump where it can be easily serviced.
2. Mount the pump to a secure surface or wall using the enclosed hardware. Wall mount to a solid surface only. Mounting to drywall with anchors is not recommended.
3. Do not move the pump directly over your chemical container. Chemical fumes may damage the unit. Mount the pump off to the side or at a lower level than the chemical container opening.
4. Mounting the lower than the chemical container will gravity feed the chemical into the pump. This "flooded suction" installation can reduce the time required to prime the pump. Install a shut-off valve, pinch clamp or other means to halt the gravity feed to the pump during servicing.
5. Your solution tank should be sturdy. Keep the tank covered to reduce fumes.
6. Be sure your installation does not constitute a cross connection with the drinking water supply. Check your local plumbing code.

C-1500N Wall Mount

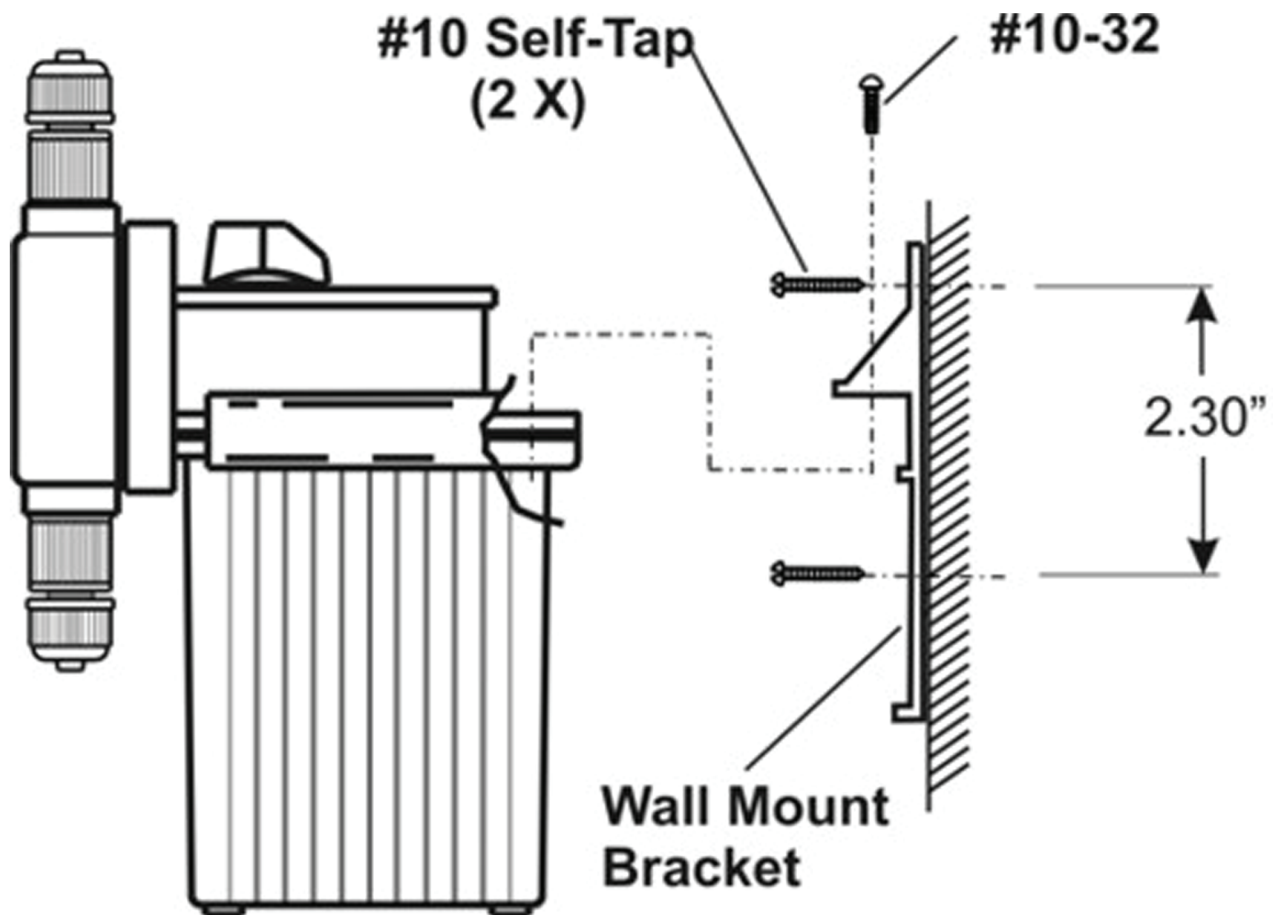

Mounting Location

1. Choose an area located near the chemical supply tank, chemical injection point and electrical supply. Although the pump is designed to withstand outdoor conditions, a cool, dry well ventilated location is recommended. Install where it can be easily serviced.
2. Mount the pump to a secure surface or wall using the enclosed hardware. Wall mount to a solid surface only. Mounting to drywall with anchors is not recommended.
3. Do not mount the pump directly over your chemical container. Chemical fumes may damage the unit. Mount the pump off to the side or at a lower level than the chemical container opening.
4. Mounting the pump lower than the chemical container will gravity feed the chemical into the pump. This "flooded suction" installation can reduce the time required to prime the pump. Install a shut-off valve, pinch clamp or other means to halt the gravity feed to the pump during servicing.
5. Your solution tank should be sturdy. Keep the tank covered to reduce fumes.
6. Be sure your installation does not constitute a cross connection with the drinking water supply. Check your local plumbing codes.

Injection Fittings

Injection fitting prevents backflow from a treated Line

1/4" and 1/2" Male NPT for pipe installation

Available tubing connection sizes:

- 1/4" tube
- 3/8" tube

The Injection Fittings are provided as standard on all Blue-White diaphragm and peristaltic metering pumps.



1/4"
tube

3/8"
tube

Injection Fitting (check valve) installation

The Injection Fitting is designed to install directly into either 1/4" or 1/2" female pipe threads (NPT).

You can trim the injection point (nose) if needed. See image to the right.

The nose section is designed to inject the chemical away from the wall of your pipe.

Injector Fittings for smaller pipe sizes are also available. The fitting does not have the same length at the injector point (nose). See image to the right.

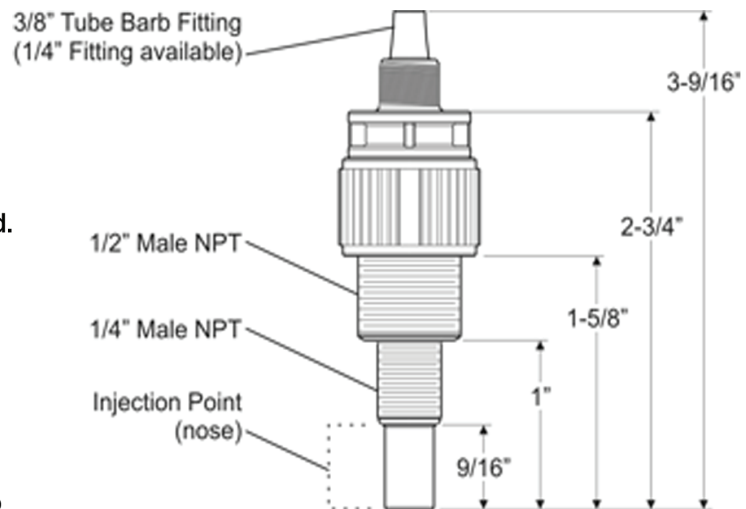

Install the injection fitting directly to a tee fitting

The solution must inject directly into the flow stream.

Use PTFE thread sealing tape on the pipe threads of the injection fitting.

This illustration shows the Injection Fitting installed in a tee fitting using the 1/2" threads.

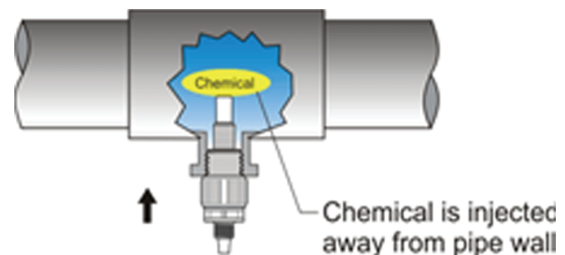

You can install the Injection Fitting directly into your pipe

Drill the correct size hole and then tap the hole for 1/4" or 1/2" NPT.

Use PTFE thread sealing tape on the pipe threads of the Injection Fitting.

This illustration shows the Injection Fitting installed directly onto pipe using the 1/4" threads.

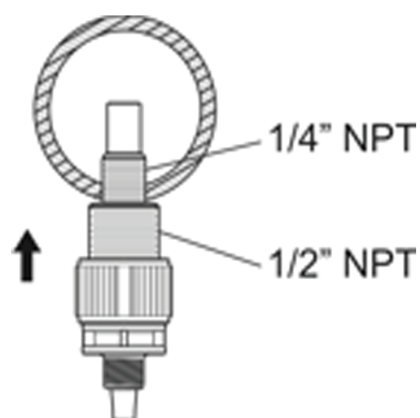

Exploded view (ball check valve)

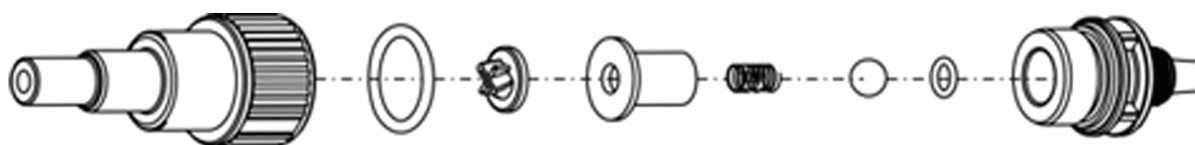

Cut an appropriate length of discharge tubing (opaque tube). Push one side of the tubing onto the compression barb of the Injection Fitting. Use the tube nut to secure the tube. Hand tighten only.

The exploded view drawing above shows the "tube nut" on the far right-hand side. The part to the left side of the "tube nut" is the "compression fitting" that the tube must fit onto.

Cleaning:

The Injection Fitting (check valve) will require periodic cleaning, especially when injecting fluids that calcify, such as sodium hypochlorate. See page – for details.

Available Injection Fittings with 1" Nose

Model No.	Tube connection (OD)	Body material	Cracking Pressure	O-ring
A-014N-4A	1/4" tubing	Polypropylene	1/2 lb.	Viton / Aflas
C-395N-4A	1/4" tubing	Polypropylene	6 lb.	Viton / Aflas
A-014N-6A	3/8" tubing	Polypropylene	1/2 lb.	Viton / Aflas
C-395N-6A	3/8" tubing	Polypropylene	6 lb.	Viton / Aflas
A-014NK-4A	1/4" tubing	PVDF	1/2 lb.	Viton / Aflas
C-395NK-4A	1/4" tubing	PVDF	6 lb.	Viton / Aflas
A-014NK-6A	3/8" tubing	PVDF	1/2 lb.	Viton / Aflas
C-395NK-6A	3/8" tubing	PVDF	6 lb.	Viton / Aflas

How to Clean Your Pump and Fittings

Periodically clean the injection fitting/check valve assembly, especially when injecting fluids that calcify such as sodium hypochlorite.

These lime deposits and other build ups can clog the fitting, which will increase the back pressure and interfere with the pump accuracy. **Warning:** Severe cases can physically damage the injection fitting and the increase back pressure can cause increased wear on the pump components; gears, bearings, and pump tubes

Please follow these steps when cleaning your injection fitting/check valves

1. Wash the pump, tubing, and fittings out with clean water.

To do this, place the “suction tubing” and “discharge tubing” (injection fitting too) in a container full of clean water.

2. Let the pump run in the clean water for a couple of minutes to remove all traces of chemical.

3. Remove the lime deposits with undiluted vinegar. To do this, place the “suction tubing” and “discharge tubing” in a container full of undiluted vinegar. See image to the right.

4. Let the pump run in the undiluted vinegar for 5 to 10 minutes (longer if needed).

5. Flush out your pump, tubing, and fittings to remove any excess vinegar.

To do this, repeat **steps 1 and 2**.

Tip: If you have a diaphragm pump head that needs cleaning, follow the same steps above. Refer to the exploded view in your instruction manual when assembling the pump head.

Tip: Follow the same steps above to clean a foot valve.

Tip: Standard injection fittings are made of Polypropylene. PVDF injection fittings are recommended for use with aggressive chemicals which are not compatible with Polypropylene. PVDF injection fittings should be considered for use with chlorine at elevated temperatures.

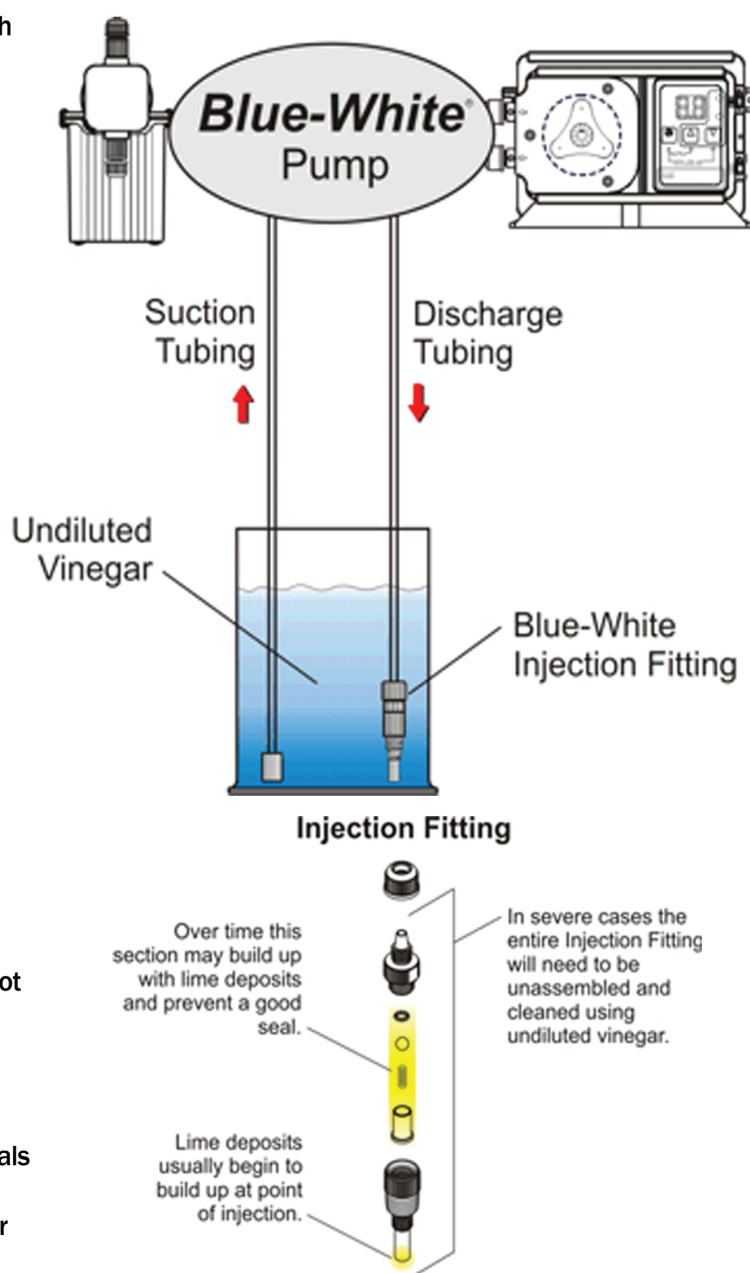

Tip: Blue-White recommends that you purchase a spare injection fitting for your pump. This is commonly the most neglected part of most pump installations. You can purchase a spare injection fitting for around \$30 (US).

Volumetric Testing

1. With the pump installed under normal operating conditions, place the suction tubing in a graduated container.
2. Fill the container with the same chemical normally injected, and run the pump until all the air is removed. (Prime the pump)
3. Refill the container if necessary, and with the foot valve in the solution, note the amount of chemical in the container.
4. Using a stopwatch or timer, run the pump for a measured amount of time (example: 1 minute). Note the amount of chemical pumped during that time.

Tip: The longer the testing time, the more accurate the measurement.

Example:

During your 1 minute calibration period, say your injector pumped 2.5 ounces.

2.5 ounces per minute (OZM)

$$\begin{array}{r} 60 \text{ (minutes per hour)} \\ \times 2.5 \text{ (your output, OZM)} \\ \hline 150 \text{ (ounces per hour)} \end{array}$$

$$\begin{array}{r} 1.17 \text{ GPH (gallons per hour)} \\ 128 \overline{) 150 \text{ (ounces per hour)}} \end{array}$$

— Ounces in a US gallon

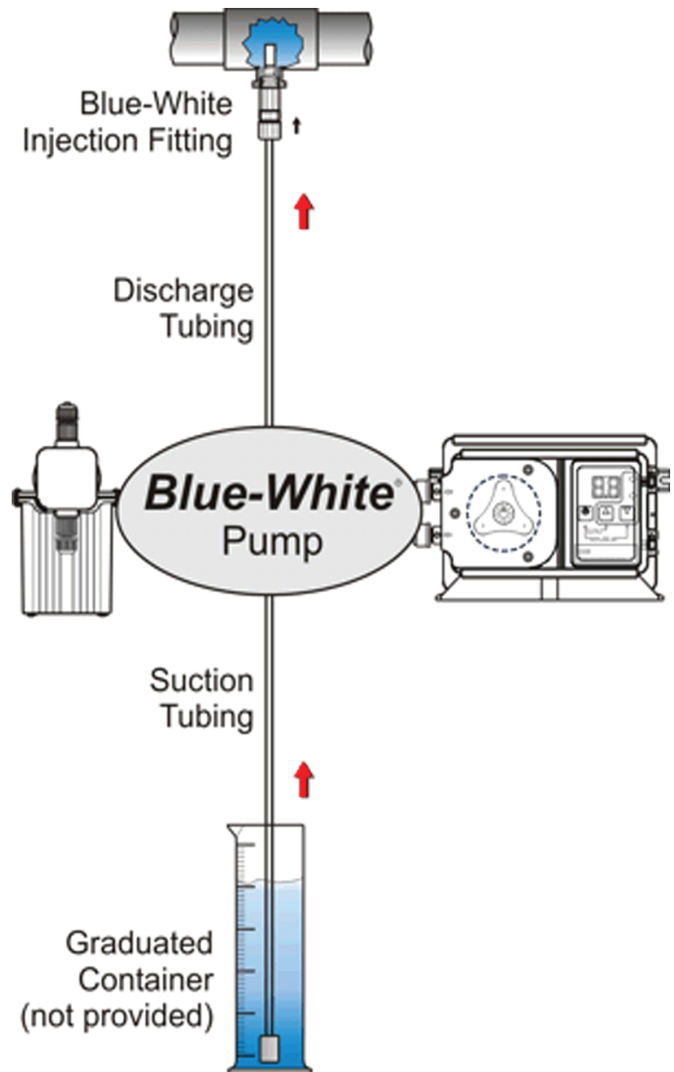

Your pump is calibrated to pump 1.17 GPH - or - 28.08 GPD